



ETA-Danmark A/S
Göteborg Plads 1
DK-2150 Nordhavn
Tel. +45 72 24 59 00
Internet www.etadanmark.dk

Authorised and notified
according to Article 29 of the
Regulation (EU)
No 305/2011 of the European
Parliament and of the Council
of 9 March 2011

MEMBER OF EOTA



European Technical Assessment ETA-20/1089 of 2023/11/23

I General Part

Technical Assessment Body issuing the ETA and designated according to Article 29 of the Regulation (EU) No 305/2011: ETA-Danmark A/S

Trade name of the construction product:

Astro Intu Mastic

Product family to which the above construction product belongs:

Fire Stopping and Sealing Product:

- Linear Joint and Gap Seals

Manufacturer:

Astroflame (fireseals) Limited
Unit 8 The IO Centre
Stephenson Road
Segensworth,
Fareham
Hampshire
PO15 5RU

Manufacturing plant:

E055

This European Technical Assessment contains:

34 pages including 3 annexes which form an integral part of the document

This European Technical Assessment is issued in accordance with Regulation (EU) No 305/2011, on the basis of:

EAD 350141-00-1106

This version replaces:

-

Translations of this European Technical Assessment in other languages shall fully correspond to the original issued document and should be identified as such.

Communication of this European Technical Assessment, including transmission by electronic means, shall be in full [except the confidential Annex(es) referred to above]. However, partial reproduction may be made with the written consent of the issuing Technical Assessment Body. Any partial reproduction has to be identified as such.

I. SPECIFIC PARTS OF THE EUROPEAN TECHNICAL ASSESSMENT

1 Technical description of the product

- 1) Astro Intu Mastic is an acrylic based sealant used to form linear gap seals where gaps are presented in wall and floor constructions and linear joint seals where wall and floor constructions abut.
- 2) Astro Intu Mastic is supplied in liquid form contained within 310 ml & 380 ml cartridges, 600 ml foils or in 5, 10, 20 or 25 litre tubs. The sealant is gunned or trowelled into the aperture in or between the separating element/elements to a specified depth using various backing materials.
- 3) The applicant has submitted a written declaration that Astro Intu Mastic does not contain substances which have to be classified as dangerous according to article 59 (1, 10) of the Regulation (EC) No 1907/2006 (REACH).

In addition to the specific clauses relating to dangerous substances contained in this European technical Assessment, there may be other requirements applicable to the products falling within its scope (e.g. transposed European legislation and national laws, regulations and administrative provisions). In order to meet the provisions of the Construction Products Regulation, these requirements need also to be complied with, when and where they apply.

- 4) The use category of Astro Intu Mastic in relation to BWR 3 (Hygiene, health and environment) is IA2

2 Specification of the intended uses of the product in accordance with the applicable European Assessment Document (Hereinafter EAD)

Detailed information and data is given in Annex A.

- 1) The intended use of system Astro Intu Mastic is to reinstate the fire resistance performance of gaps in and joints in and between flexible and rigid wall constructions, gaps in and joints between rigid floor constructions.
- 2) The specific elements of construction that the system Astro Intu Mastic may be used to provide a gap or joint seal in, are as follows:
 - a. Flexible walls: The wall must have a minimum thickness of 75 mm and comprise steel studs or timber studs lined on both faces with minimum 1 layer of 12.5 mm thick boards.
 - b. Rigid walls: The wall must have a minimum thickness of 75 mm and comprise concrete, aerated concrete or masonry with a minimum density of 650 kg/m³.
 - c. Rigid floors: The floor must have a minimum thickness of 150 mm and comprise aerated concrete or concrete with a minimum density of 650 kg/m³.

The supporting construction must be classified in accordance with EN 13501-2 for the required fire resistance period.

- 3) The System Astro Intu Mastic may be used to provide a linear joint or gap seal with specific supporting constructions and substrates (for details see Annex A).
- 4) The maximum permitted joint/gap width for system Astro Intu Mastic is 60 mm.
- 5) The maximum movement capability of system Astro Intu Mastic is $\leq 7.5\%$ depending on the application and installation (for details see Annex A).
- 6) The provisions made in this European Technical Assessment are based on an assumed working life of the Astro Intu Mastic of 25 years, provided that the conditions laid down in the product datasheet for the packaging/transport/ storage/installation/use/repair are met. The indications given on the working life cannot be interpreted as a guarantee given by the producer or the Technical Assessment Body, but are to be regarded only as a means for choosing the right products in relation to the expected economically reasonable working life of the works.
- 7) Type X: Intended for use in conditions exposed to weathering and all lower classes.

3 Performance of the product and references to the methods used for its assessment

Product-type: Intumescent sheet	Intended use: Penetration Seal
Essential characteristic	Product performance
BWR 2 Safety in case of fire	
Reaction to fire	No performance assessed
Resistance to fire	Annex A
BWR 3 Hygiene, health and environment	
Content, emission and/or release of dangerous substances	Use categories: IA2 Declaration of manufacturer
Air permeability (material property)	Annex B
Water permeability (material property)	No performance assessed
BWR 4 Safety in use	
Mechanical resistance and stability	No performance assessed
Resistance to impact/movement	No performance assessed
Adhesion	7.5P
Durability	Type X
Movement capacity	Annex A
Cycling of perimeter seals for curtain walls	No performance assessed
Compression set	No performance assessed
Linear expansion on setting	No performance assessed
BWR 5 Protection against noise	
Airborne sound insulation	Annex C
BWR 6 Energy economy and heat retention	
Thermal properties	No performance assessed
Water vapour permeability	No performance assessed

4 ASSESSMENT AND VERIFICATION OF CONSTANCY OF PERFORMANCE (HEREINAFTER AVCP) SYSTEM APPLIED, WITH REFERENCE TO ITS LEGAL BASE

According to the decision 1999/454/EC – Commission Decision of date 22nd June 1999 on the procedure for attesting the conformity of construction products pursuant to Article 20(2) of Council Directive 89/106/EEC as regards fire stopping, fire sealing and fire protective products, published in the Official Journal of the European Union (OJEU) L178/52 of 14/07/1999, (see <https://eur-lex.europa.eu/oj/direct-access.html>) of the European Commission¹, as amended, the system(s) of assessment and verification of constancy of performance (see Annex V to Regulation (EU) No 305/2011) given in the following table(s) applies (apply).

Product(s)	Intended use(s)	Level(s) or class(es)	System(s)
Fire stopping and Fire Sealing Products	For fire compartmentation and/or fire protection or fire performance	Any	1

5 Technical details necessary for the implementation of the AVCP system, as provided for in the applicable EAD

Technical details necessary for the implementation of the AVCP system are laid down in the control plan deposited at ETA-Danmark A/S prior to CE marking

Issued in Copenhagen on 2023-11-23 by

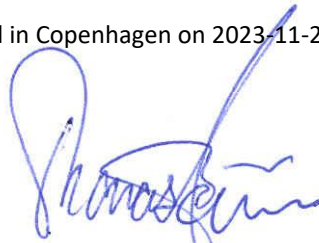

Thomas Bruun

Managing Director, ETA-Danmark

¹ Official Journal of the European Communities L178/52 of 14/7/1999

ANNEX A – Resistance to Fire Classification – Astro Intu Mastic

A.1 Flexible and rigid wall constructions with wall thickness of minimum 75 mm

A.1.1 Double sided linear joint seal

Joint Seal: Astro Intu Mastic sealant to both sides of the wall, backed with a 50 mm depth of stone wool or ceramic wool (45kg/m³), joint widths up to 25 mm.

Construction details:

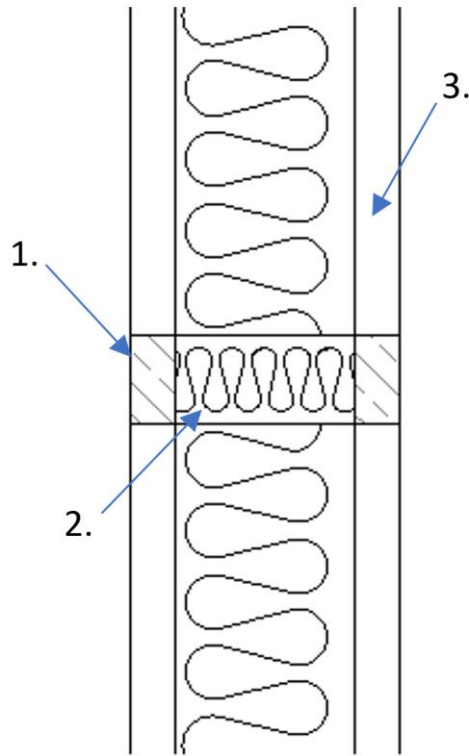

Key:

1. Astro Intu Mastic Sealant
2. Backing Material
3. Flexible Wall

A.1.1.1

Substrate	Depth (mm)	Backing Material	Classification
Flexible / flexible	12.5	Stone wool or ceramic wool (50mm 45kg/m ³)	E 60 – V – X – F – W 00 to W 25
Masonry / masonry			EI 45 – V – X – F – W 00 to W 25

A.2 Flexible and rigid wall constructions with wall thickness of minimum 120 mm

A.2.1 Double sided linear joint seal

Joint Seal: Astro Intu Mastic sealant to both sides of the wall, backed with PE backing rod, glass wool, stone wool or ceramic wool, joint widths up to 20 mm.

Construction details:

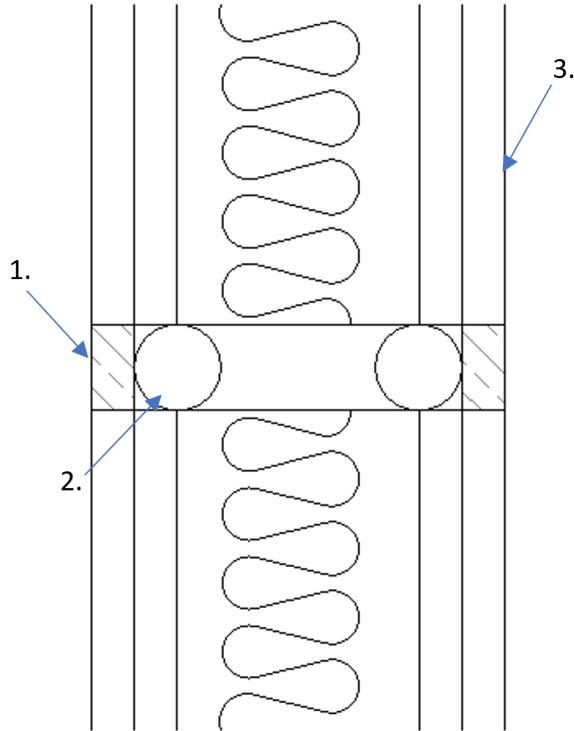

Key:

1. Astro Intu Mastic Sealant
2. Backing Material
3. Flexible Wall

A.2.1.1

Substrate	Depth (mm)	Backing Material	Classification
Flexible / flexible	12.5	PE backing rod, glass wool, stone wool or ceramic wool	EI 120 – V – X – F – W 00 to W 20
Masonry / masonry			

A.2.2 Double sided head of wall joint seal

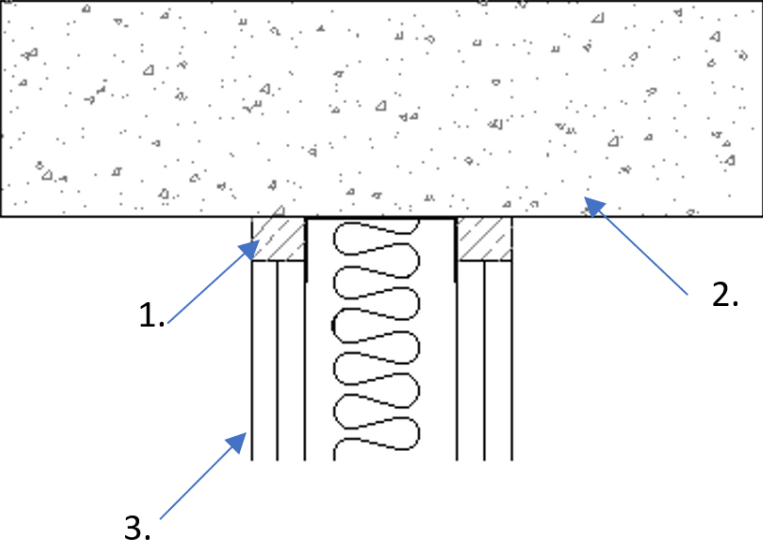
Joint Seal: Astro Intu Mastic sealant to both sides of the wall, joint widths up to 20 mm.	
<p>Construction details:</p> 	<p>Key:</p> <ol style="list-style-type: none"> 1. <u>Astro Intu Mastic Sealant</u> 2. <u>Rigid Floor</u> 3. <u>Flexible Wall</u>

A.2.2.1

Substrate	Depth (mm)	Backing Material	Classification
Flexible / concrete	25	Steel head track	EI 120 – T – X – F – W 00 to W 20
Masonry / concrete			

A.3 Rigid wall constructions with wall thickness of minimum 100 mm

A.3.1 Single sides linear joint seal

Joint Seal: Astro Intu Mastic sealant to either side of the wall, joint widths up to 50 mm.

Construction details:

Key:

1. Astro Intu Mastic Sealant Installed Either Side of Wall
2. Backing Material
3. Rigid Wall

A.3.1.1

Substrate	Depth (mm)	Backing Material	Classification
Concrete / masonry	25	PE backing rod, glass wool, stone wool or ceramic wool	E 120 – V – X – F – W 00 to W 50 EI 60 – V – X – F – W 00 to W 50
	2:1 ratio (width:depth) & Min. 10		E 120 – V – X – F – W 00 to W 50 EI 45 – V – X – F – W 00 to W 50

A.3.2 Single sided linear joint seal with steel faced wall

Joint Seal: Astro Intu Mastic sealant to either side of the wall.

Construction details:

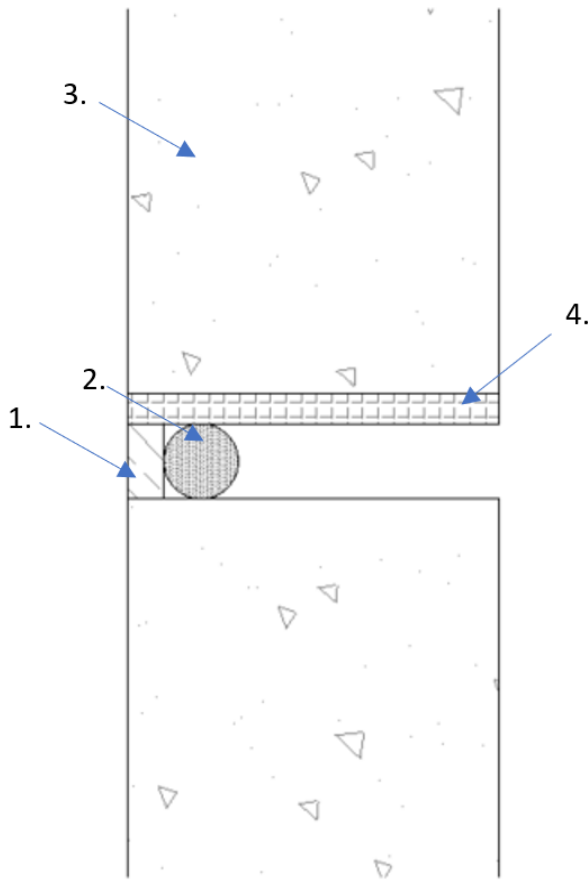

Key:

1. Astro Intu Mastic Sealant Installed Either Side of Wall
2. Backing Material
3. Rigid Wall
4. Steel

A.3.2.1

Substrate	Depth (mm)	Backing Material	Classification
Concrete or masonry / steel	10	PE backing rod, glass wool, stone wool or ceramic wool	E 120 – V – X – F – W 00 to W 20 EI 20 – V – X – F – W 00 to W 20
	2:1 ratio (width:depth) & Min. 10		E 45 – V – X – F – W 00 to W 50 EI 20 – V – X – F – W 00 to W 50

A.3.3 Single sided linear joint seal with timber faced wall

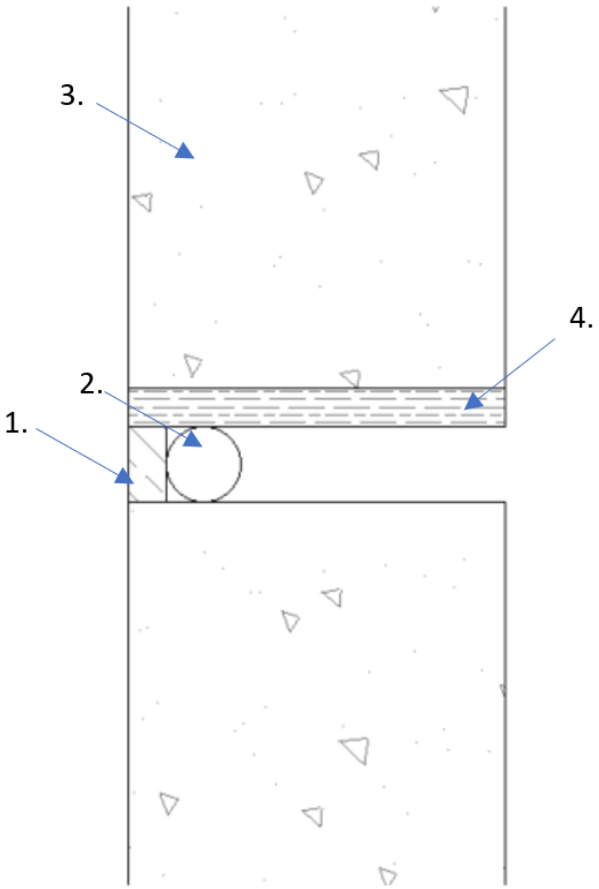
Joint Seal: Astro Intu Mastic sealant to either side of the wall, joint widths up to 50 mm.	
<p>Construction details:</p> 	<p>Key:</p> <ol style="list-style-type: none"> 1. <u>Astro Intu Mastic Sealant Installed Either Side of Wall</u> 2. <u>Backing Material</u> 3. <u>Rigid Wall</u> 4. <u>Timber</u>

A.3.3.1

Substrate	Depth (mm)	Backing Material	Classification
Concrete or masonry / timber	2:1 ratio (width:depth) & Min. 10	PE backing rod, glass wool, stone wool or ceramic wool	E 30 – V – X – F – W 00 to W 50 EI 20 – V – X – F – W 00 to W 50
	25		EI 45 – V – X – F – W 00 to W 50

A.4 Rigid wall constructions with wall thickness of minimum 150 mm

A.4.1 Double sided linear joint seal

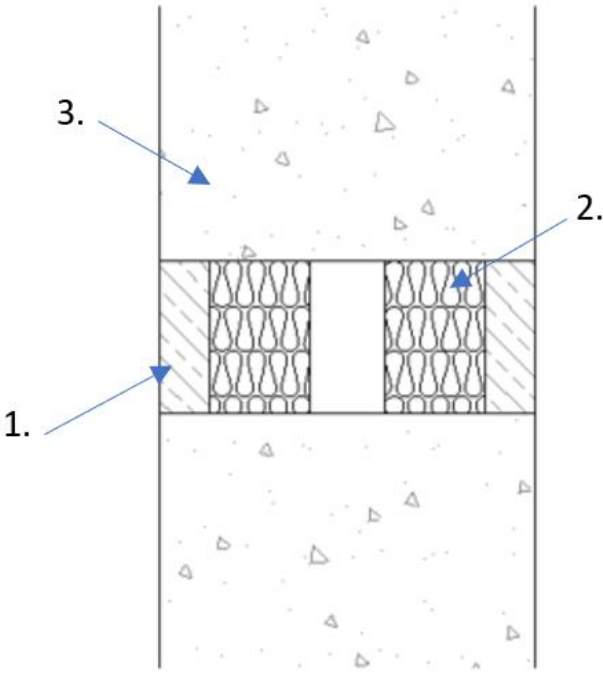
Joint Seal: Astro Intu Mastic sealant to both sides of the wall, joint widths up to 60 mm.	
<p>Construction details:</p> 	<p>Key:</p> <ol style="list-style-type: none"> 1. <u>Astro Intu Mastic Sealant</u> 2. <u>Backing Material</u> 3. <u>Rigid Wall</u>

A.4.1.1

Substrate	Depth (mm)	Backing Material	Classification
Concrete / masonry	30	Stone wool or ceramic wool ($\geq 40\text{mm} \geq 45\text{kg/m}^3$)	EI 240 – V – X – F – W 00 to W 60

A.4.2 Double sided linear joint seal

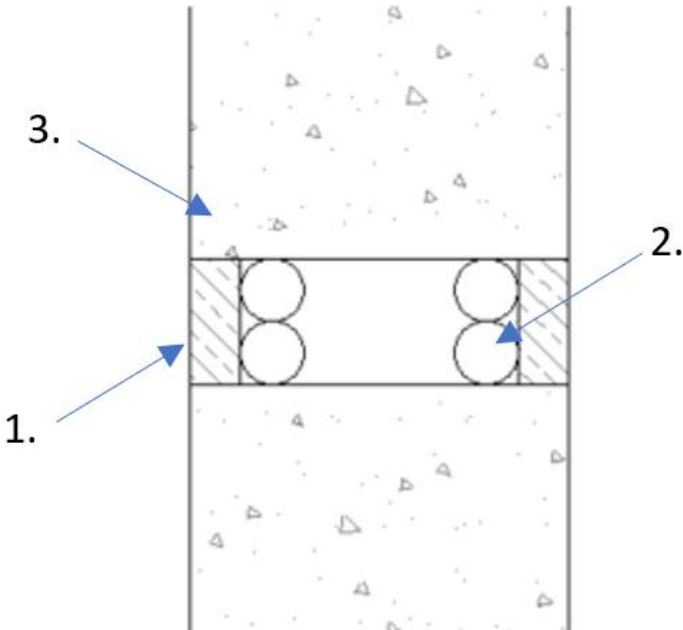
<p>Joint Seal: Astro Intu Mastic sealant to both sides of the wall, joint widths up to 50 mm.</p>	
<p>Construction details:</p> 	<p>Key:</p> <ol style="list-style-type: none"> 1. <u>Astro Intu Mastic Sealant</u> 2. <u>Backing Material</u> 3. <u>Rigid Wall</u>

A.4.2.1

Substrate	Depth (mm)	Backing Material	Classification
Concrete / masonry	25	PE backing rod, glass wool, stone wool or ceramic wool	EI 240 – V – X – F – W 00 to W 50

A.4.3 Double sided linear joint seal with steel faced wall

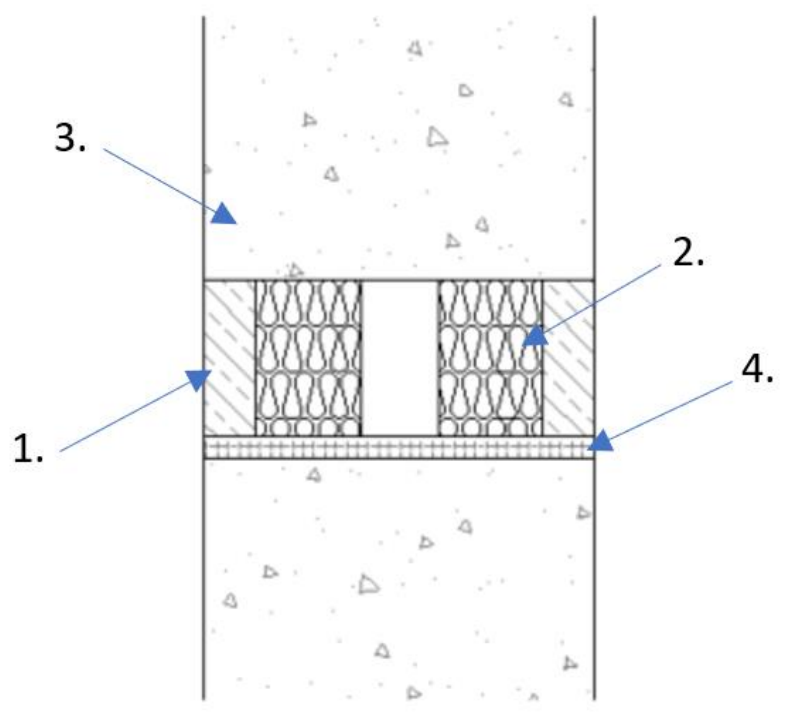
Joint Seal: Astro Intu Mastic sealant to both sides of the wall, joint widths up to 60 mm.	
<p>Construction details:</p> 	<p>Key:</p> <ol style="list-style-type: none"> 1. <u>Astro Intu Mastic Sealant</u> 2. <u>Backing Material</u> 3. <u>Rigid Wall</u> 4. <u>Steel</u>

A.4.3.1

Substrate	Depth (mm)	Backing Material	Classification
Concrete or masonry / steel	30	Stone wool or ceramic wool (≥40mm ≥45kg/m ³)	E 240 – V – X – F – W 00 to W 60 EI 60 – V – X – F – W 00 to W 60

A.4.4 Double sided linear joint seal with timber faced wall

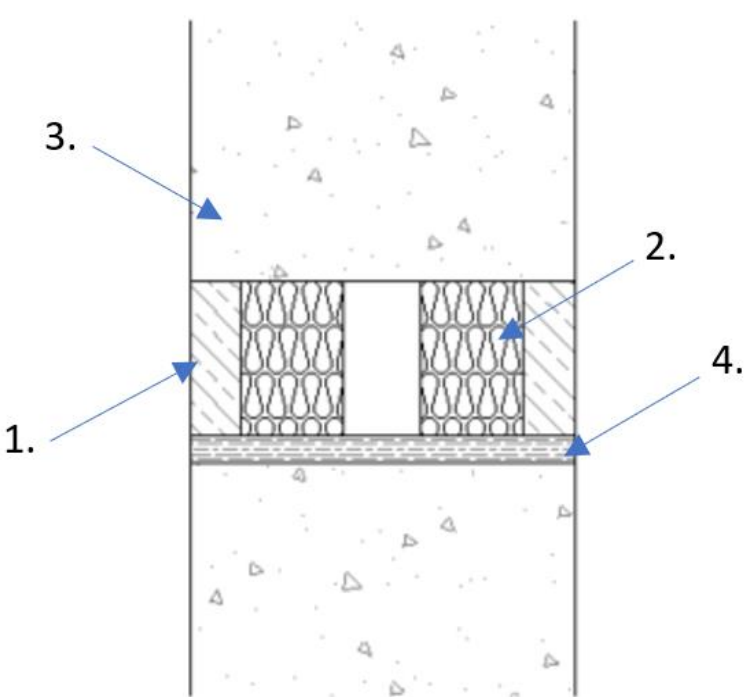
Joint Seal: Astro Intu Mastic sealant to both sides of the wall, joint widths up to 60 mm.	
<p>Construction details:</p> 	<p>Key:</p> <ol style="list-style-type: none"> 1. <u>Astro Intu Mastic Sealant</u> 2. <u>Backing Material</u> 3. <u>Rigid Wall</u> 4. <u>Timber</u>

A.4.4.1

Substrate	Depth (mm)	Backing Material	Classification
Concrete or masonry / timber	30	Stone wool or ceramic wool (≥40mm ≥45kg/m ³)	EI 60 – V – X – F – W 00 to W 60

A.4.5 Double sided linear joint seal with movement

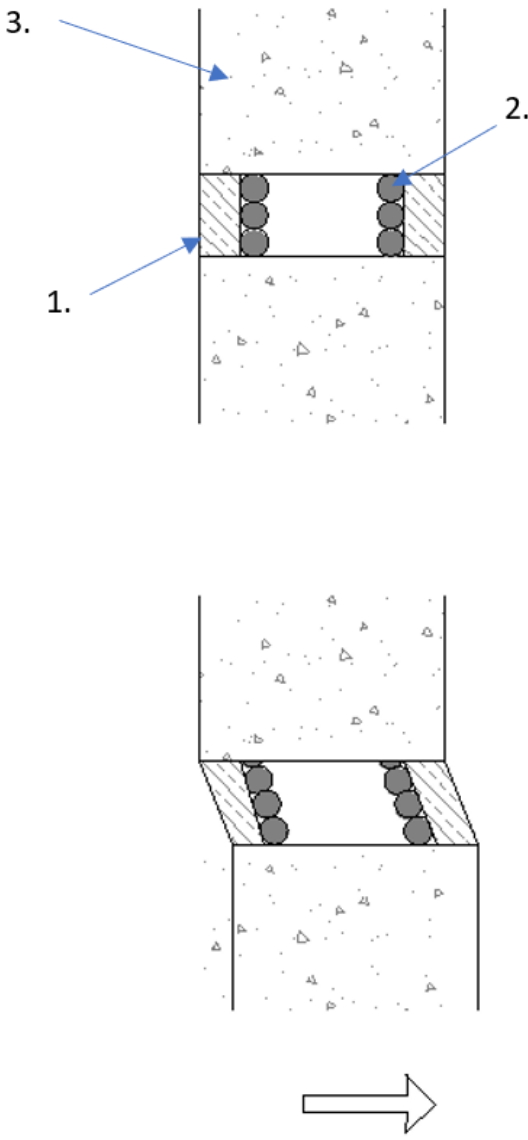
Joint Seal: Astro Intu Mastic sealant to both sides of the wall, joint widths up to 60 mm.	
<p>Construction details:</p> 	<p>Key:</p> <ol style="list-style-type: none"> 1. <u>Astro Intu Mastic Sealant</u> 2. <u>Backing Material</u> 3. <u>Rigid Wall</u>

A.4.5.1

Substrate	Depth (mm)	Backing Material	Classification
Concrete / masonry	20	PE backing rod, glass wool, stone wool or ceramic wool	E 240 – V – M 25 – F – W 00 to W 60 EI 120 – V – M 25 – F – W 00 to W 60

A.4.6 Single sided linear joint seal with movement

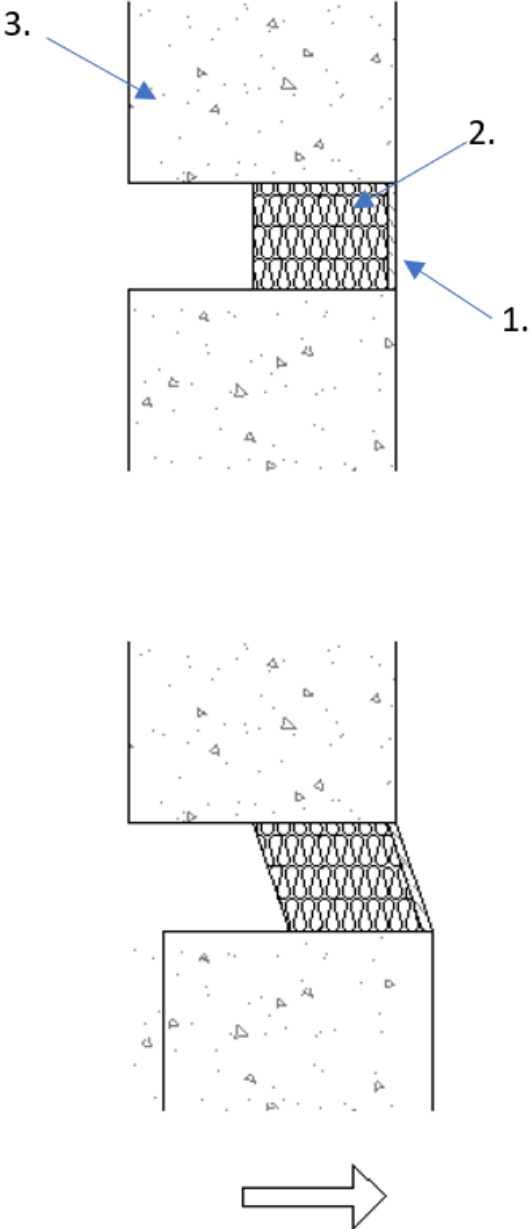
Joint Seal: Astro Intu Mastic sealant either side of the wall, joint widths up to 60 mm.	
<p>Construction details:</p> 	<p>Key:</p> <ol style="list-style-type: none"> 1. <u>Astro Intu Mastic Sealant Installed Either Side of Wall</u> 2. <u>Backing Material</u> 3. <u>Rigid Wall</u>

A.4.6.1

Substrate	Depth (mm)	Backing Material	Classification
Concrete / masonry	5	Stone wool or ceramic wool (≥75mm ≥60kg/m ³ , compressed to 60%)	E 240 – V – M 25 – F – W 00 to W 60 EI 120 – V – M 25 – F – W 00 to W 60

A.5 Rigid floor constructions with floor depth of minimum 150 mm

A.5.1 Single sided linear joint seal in floor from underside

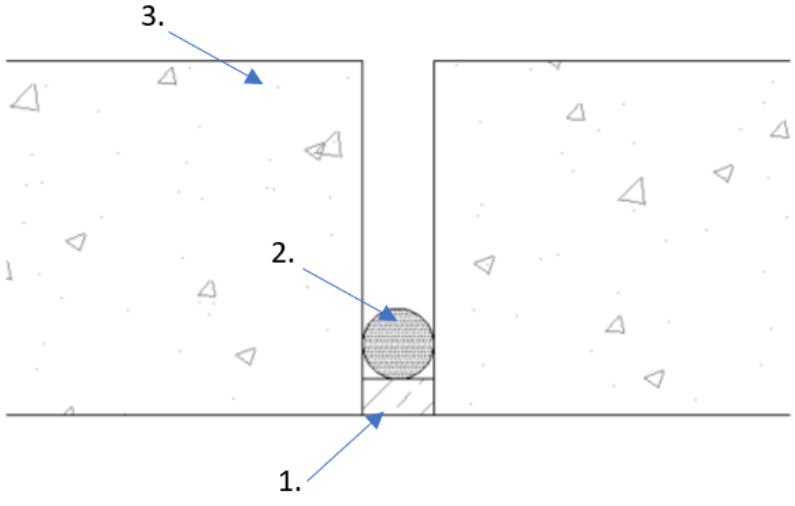
<p>Joint Seal: Astro Intu Mastic sealant flush to the underside of the floor, joint widths up to 50 mm.</p>	
<p>Construction details:</p> 	<p>Key:</p> <ol style="list-style-type: none"> 1. <u>Astro Intu Mastic Sealant</u> 2. <u>Backing Material</u> 3. <u>Rigid Floor</u>

A.5.1.1

Substrate	Depth (mm)	Backing Material	Classification
Concrete / masonry	25	PE backing rod, glass wool, stone wool or ceramic wool	E 240 – H – X – F – W 00 to W 50 EI 90 – H – X – F – W 00 to W 50
	2:1 ratio (width:depth) & Min. 10		E 240 – H – X – F – W 00 to W 50 EI 45 – H – X – F – W 00 to W 50

A.5.2 Single sided linear joint seal in floor from top side

Joint Seal: Astro Intu Mastic sealant flush to the top side of the floor, joint widths up to 50 mm.

Construction details:

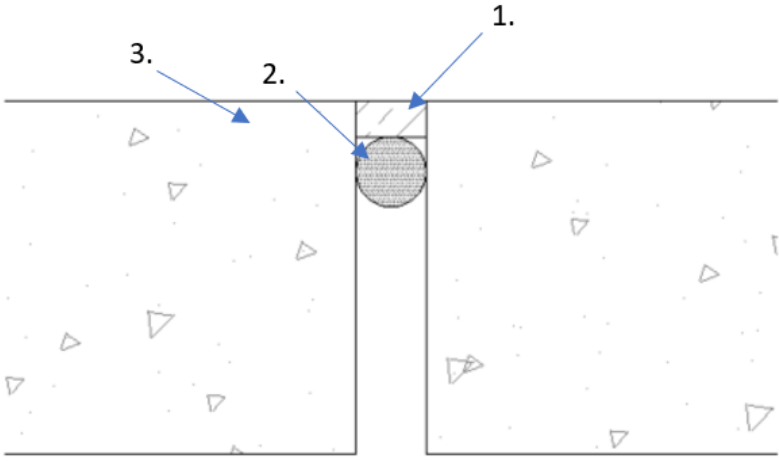

Key:

1. Astro Intu Mastic Sealant
2. Backing Material
3. Rigid Floor

A.5.2.1

Substrate	Depth (mm)	Backing Material	Classification
Concrete / masonry	25	PE backing rod, glass wool, stone wool or ceramic wool	E 240 – H – X – F – W 00 to W 50 EI 90 – H – X – F – W 00 to W 50
	2:1 ratio (width:depth) & Min. 10		E 240 – H – X – F – W 00 to W 50 EI 45 – H – X – F – W 00 to W 50

A.5.3 Single sided linear joint seal in steel faced floor from underside

Joint Seal: Astro Intu Mastic sealant flush to the underside of the floor, joint widths up to 50 mm.	
<p>Construction details:</p>	<p>Key:</p> <ol style="list-style-type: none"> 1. <u>Astro Intu Mastic Sealant</u> 2. <u>Backing Material</u> 3. <u>Rigid Floor</u> 4. <u>Steel</u>

A.5.3.1

Substrate	Depth (mm)	Backing Material	Classification
Concrete or masonry / steel	25	PE backing rod, glass wool, stone wool or ceramic wool	E 240 – H – X – F – W 00 to W 50 EI 90 – H – X – F – W 00 to W 50
	2:1 ratio (width:depth) & Min. 10		E 120 – H – X – F – W 00 to W 50 EI 30 – H – X – F – W 00 to W 50

A.5.4 Single sided linear joint seal in steel faced floor from top side

Joint Seal: Astro Intu Mastic sealant flush to the top side of the floor, joint widths up to 50 mm.	
<p>Construction details:</p>	<p>Key:</p> <ol style="list-style-type: none"> 1. <u>Astro Intu Mastic Sealant</u> 2. <u>Backing Material</u> 3. <u>Rigid Floor</u> 4. <u>Steel</u>

A.5.4.1

Substrate	Depth (mm)	Backing Material	Classification
Concrete or masonry / steel	25	PE backing rod, glass wool, stone wool or ceramic wool	E 240 – H – X – F – W 00 to W 50 EI 90 – H – X – F – W 00 to W 50
	2:1 ratio (width:depth) & Min. 10		E 120 – H – X – F – W 00 to W 50 EI 30 – H – X – F – W 00 to W 50

A.5.5 Single sided linear joint seal in timber faced floor from underside

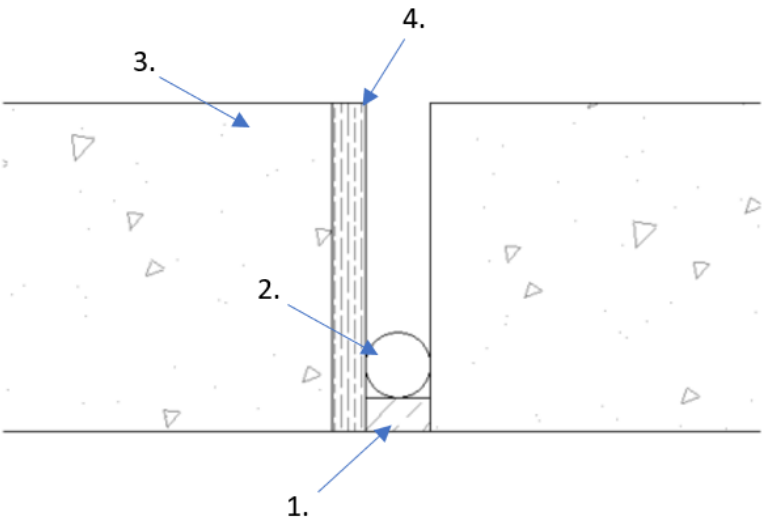
Joint Seal: Astro Intu Mastic sealant flush to the underside of the floor, joint widths up to 50 mm.	
<p>Construction details:</p> 	<p>Key:</p> <ol style="list-style-type: none"> 1. <u>Astro Intu Mastic Sealant</u> 2. <u>Backing Material</u> 3. <u>Rigid Floor</u> 4. <u>Timber</u>

A.5.5.1

Substrate	Depth (mm)	Backing Material	Classification
Concrete or masonry / timber	25	PE backing rod, glass wool, stone wool or ceramic wool	EI 45 – H – X – F – W 00 to W 50
	2:1 ratio (width:depth) & Min. 10		EI 30 – H – X – F – W 00 to W 50

A.5.6 Single sided linear joint seal in timber faced floor from top side

Joint Seal: Astro Intu Mastic sealant flush to the top side of the floor, joint widths up to 50 mm.	
<p>Construction details:</p>	<p>Key:</p> <ol style="list-style-type: none"> 1. <u>Astro Intu Mastic Sealant</u> 2. <u>Backing Material</u> 3. <u>Rigid Floor</u> 4. <u>Timber</u>

A.5.6.1

Substrate	Depth (mm)	Backing Material	Classification
Concrete or masonry / timber	25	PE backing rod, glass wool, stone wool or ceramic wool	EI 45 – H – X – F – W 00 to W 50
	2:1 ratio (width:depth) & Min. 10		EI 30 – H – X – F – W 00 to W 50

A.5.7 Single sided linear joint seal in floor from top side with movement

Joint Seal: Astro Intu Mastic sealant flush to the top side of the floor, joint widths up to 60 mm.

Construction details:

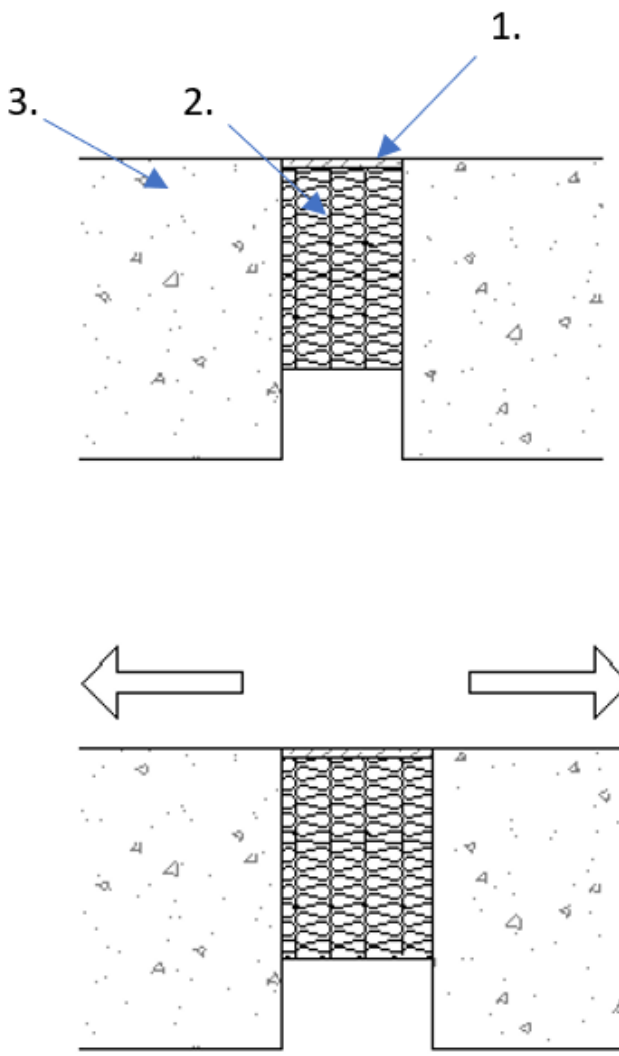

Key:

1. Astro Intu Mastic Sealant
2. Backing Material
3. Rigid Floor

A.5.7.1

Substrate	Depth (mm)	Backing Material	Classification
Concrete / masonry	5	Stone wool or ceramic wool ($\geq 100\text{mm}$ $\geq 60\text{kg/m}^3$, compressed to 60%)	EI 240 – H – M 25 – F – W 00 to W 60

A.5.8 Double sided linear joint seal in floor with movement

Joint Seal: Astro Intu Mastic sealant to both sides of the floor, joint widths up to 60 mm.

Construction details:

Key:

1. Astro Intu Mastic Sealant
2. Backing Material
3. Rigid Floor

A.5.8.1

Substrate	Depth (mm)	Backing Material	Classification
Concrete / masonry	20	PE backing rod, glass wool, stone wool or ceramic wool	E 240 – H – M 17 – F – W 00 to W 60 EI 60 – H – M 17 – F – W 00 to W 60

A.6 Head of wall with thickness of minimum 150 mm

A.6.1 Single sided head of wall joint in floor

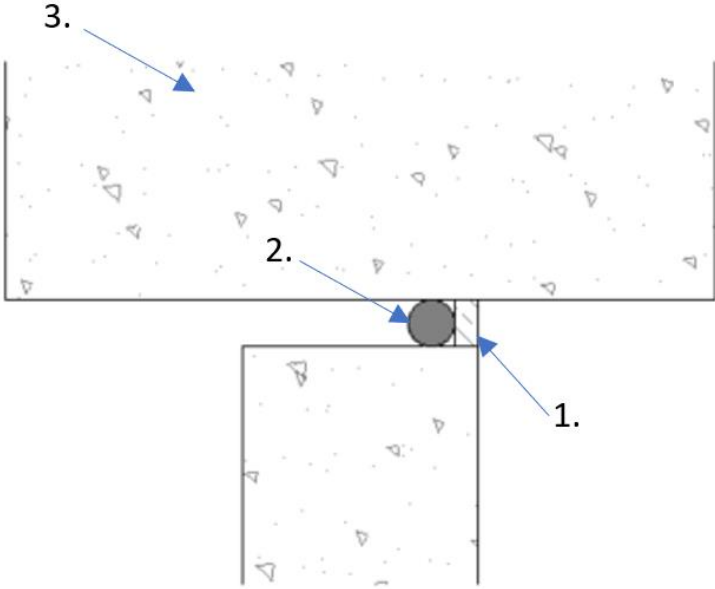
<p>Joint Seal: Astro Intu Mastic sealant to either side of the wall, joint widths up to 50 mm.</p>	
<p>Construction details:</p> 	<p>Key:</p> <ol style="list-style-type: none"> 1. <u>Astro Intu Mastic Sealant Installed Either Side of Wall</u> 2. <u>Backing Material</u> 3. <u>Rigid Floor</u>

A.6.1.1

Substrate	Depth (mm)	Backing Material	Classification
Concrete / masonry	25	PE backing rod, glass wool, stone wool or ceramic wool	E 240 – T – X – F – W 00 to W 50 EI 90 – T – X – F – W 00 to W 50
	2:1 ratio (width:depth) & Min. 10		E 240 – T – X – F – W 00 to W 50 EI 45 – T – X – F – W 00 to W 50

A.6.2 Single sided head of wall joint with steel face

Joint Seal: Astro Intu Mastic sealant to either side of the wall, joint widths up to 50 mm.

Construction details:

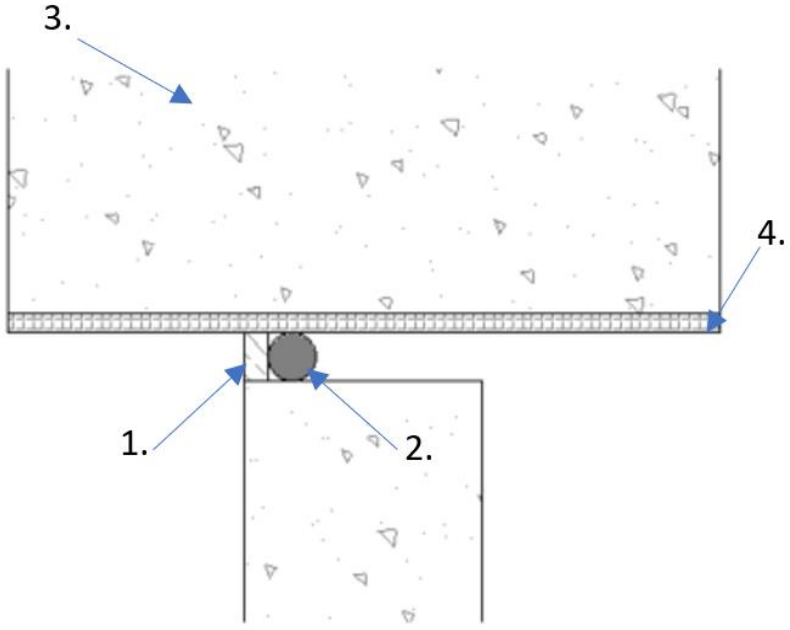

Key:

1. Astro Intu Mastic Sealant Installed Either Side of Wall
2. Backing Material
3. Rigid Floor
4. Steel

A.6.2.1

Substrate	Depth (mm)	Backing Material	Classification
Concrete or masonry / steel	25	PE backing rod, glass wool, stone wool or ceramic wool	E 240 – T – X – F – W 00 to W 50 EI 90 – T – X – F – W 00 to W 50
	2:1 ratio (width:depth) & Min. 10		E 240 – T – X – F – W 00 to W 50 EI 30 – T – X – F – W 00 to W 50

A.6.3 Single sided head of wall joint with timber face

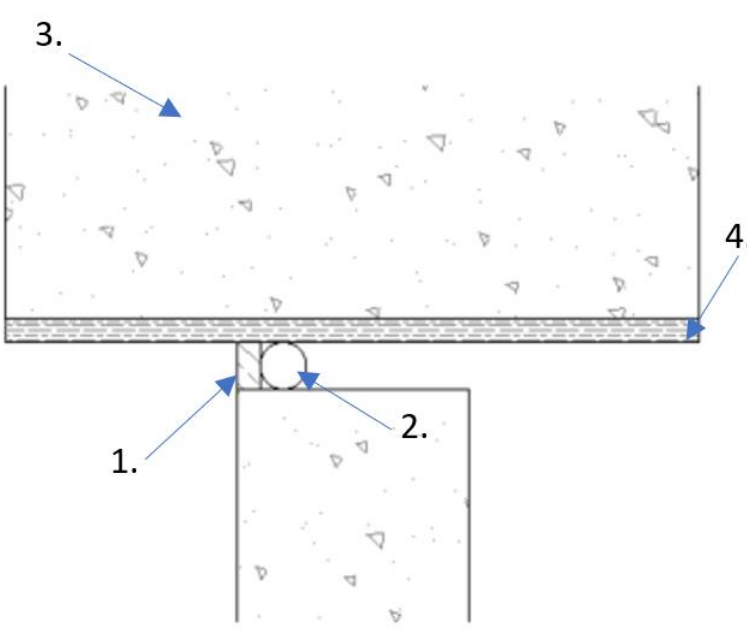
Joint Seal: Astro Intu Mastic sealant to either side of the wall, joint widths up to 50 mm.	
<p>Construction details:</p> 	<p>Key:</p> <ol style="list-style-type: none"> 1. <u>Astro Intu Mastic Sealant Installed Either Side of Wall</u> 2. <u>Backing Material</u> 3. <u>Rigid Floor</u> 4. <u>Timber</u>

A.6.3.1

Substrate	Depth (mm)	Backing Material	Classification
Concrete or masonry / timber	25	PE backing rod, glass wool, stone wool or ceramic wool	EI 45 – T – X – F – W 00 to W 50
	2:1 ratio (width:depth) & Min. 10		EI 30 – T – X – F – W 00 to W 50

A.6.4 Double sided head of wall joint with movement

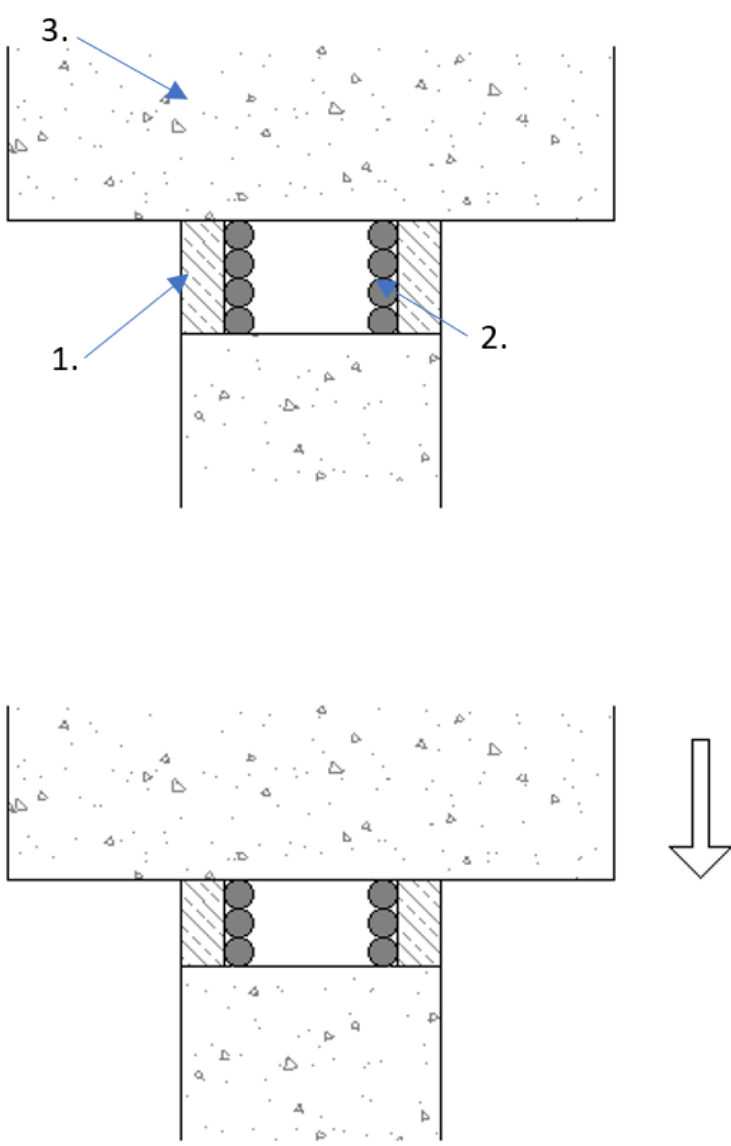
Joint Seal: Astro Intu Mastic sealant to both sides of the wall, joint widths up to 60 mm.	
<p>Construction details:</p> 	<p>Key:</p> <ol style="list-style-type: none"> 1. <u>Astro Intu Mastic Sealant</u> 2. <u>Backing Material</u> 3. <u>Rigid Floor</u>

A.6.4.1

Substrate	Depth (mm)	Backing Material	Classification
Concrete / masonry	20	PE backing rod, glass wool, stone wool or ceramic wool	E 240 – T – M 17 – F – W 00 to W 60 EI 60 – T – M 17 – F – W 00 to W 60

A.6.5 Double sided head of wall joint with movement

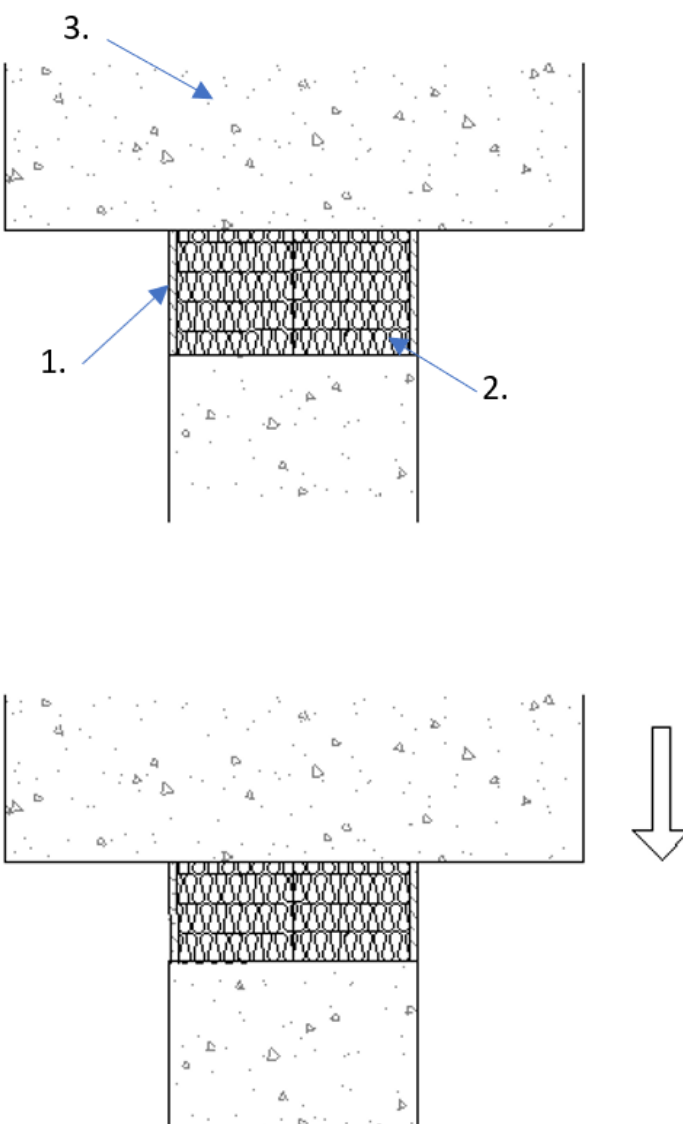
Joint Seal: Astro Intu Mastic sealant to both sides of the wall, joint widths up to 60 mm.	
<p>Construction details:</p> 	<p>Key:</p> <ol style="list-style-type: none"> 1. <u>Astro Intu Mastic Sealant</u> 2. <u>Backing Material</u> 3. <u>Rigid Floor</u>

A.6.5.1

Substrate	Depth (mm)	Backing Material	Classification
Concrete / masonry	5	Stone wool or ceramic wool (≥70mm (x2) ≥60kg/m ³ , compressed to 60%)	EI 240 – T – M 25 – F – W 00 to W 60

ANNEX B – Air Permeability - Astro Intu Mastic

Product tested	25 mm thick x 30 mm wide Astro Intu Mastic intumescent sealant		
	Summary of testing procedure		Result
	Pressure (Pa)	Leakage (m³/h)	Leakage (m³/m²/h)
Results under negative chamber pressure	50	0.0	0.0
	100	0.0	0.0
	150	0.1	2.8
	200	0.1	2.8
	250	0.1	2.8
	300	0.0	0.0
	450	0.1	2.8
	600	0.1	2.8
Results under positive chamber pressure	50	0.0	0.0
	100	0.0	0.0
	150	0.0	0.0
	200	0.0	0.0
	250	0.0	0.0
	300	0.0	0.0
	450	0.1	2.8
	600	0.1	2.8

ANNEX C – Airborne Sound Insulation - Astro Intu Mastic

C.1 Astro Intu Mastic sealant at 15 mm deep in the following configuration

**Astro Intu Mastic SEALANT TESTED TO EN 10140-2:2010
THROUGH A FLEXIBLE CONSTRUCTION**

ACOUSTIC TEST RESULTS	
Partition & Sealant Result	63 Rw dB
Sealant Result	51 Rw dB
Sealant Result	61 Dnew dB

The diagram illustrates a cross-section of a wall assembly. It consists of two vertical construction elements (3) with a hatched pattern, separated by a central cavity. This cavity is filled with stone wool (2) and has a 15mm deep sealant (1) applied to one side of the wall. A spring symbol is shown in the center of the wall assembly, indicating its flexibility.

1 - Astro Intu Mastic SEALANT TO ONE SIDE OF WALL 15mm DEPTH
2 - 55mm DEPTH STONE WOOL 60kg DENSITY
3 - CONSTRUCTING ELEMENT RATED TO 65 dB

BWR 5 Protection against noise		
Assessment method	Essential characteristic	Product performance
EN 10140-1,2,4,5/ EN ISO 717-1	Airborne sound insulation	Rw (C;Ctr)= 63(-1;-7)

C.2 Astro Intu Mastic sealant at 25 mm deep in the following configuration

**Astro Intu Mastic SEALANT TESTED TO EN 10140-2:2010
THROUGH A FLEXIBLE CONSTRUCTION**

ACOUSTIC TEST RESULTS	
Partition & Sealant Result	63 Rw dB
Sealant Result	51 Rw dB
Sealant Result	61 Dnew dB

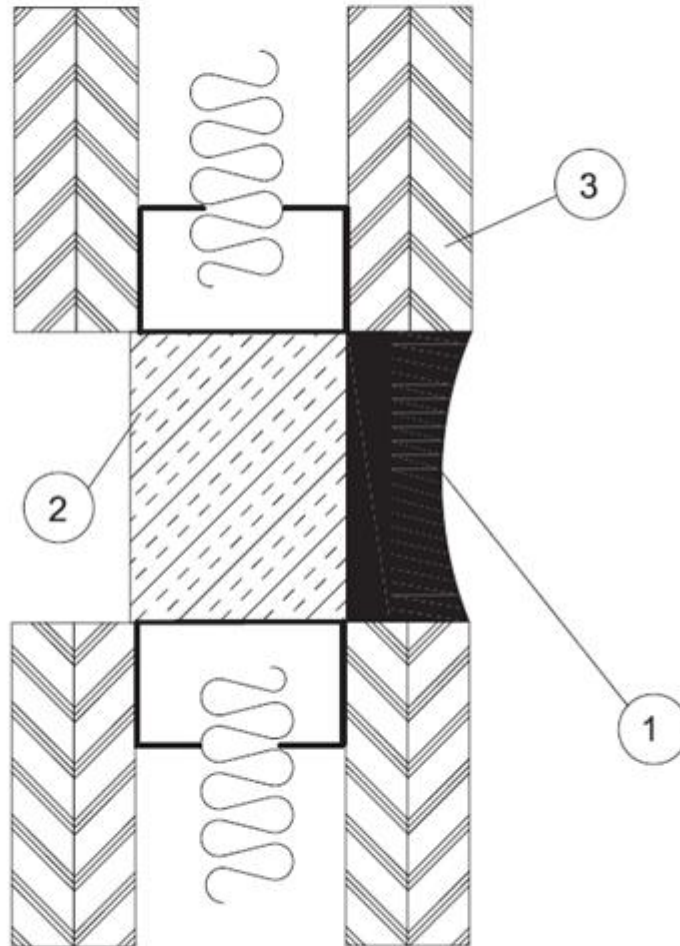

- 1 - Astro Intu Mastic SEALANT TO ONE SIDE OF WALL 25mm DEPTH**
- 2 - 55mm DEPTH STONE WOOL 60kg DENSITY**
- 3 - CONSTRUCTING ELEMENT RATED TO 65 dB**

BWR 5 Protection against noise		
Assessment method	Essential characteristic	Product performance
EN 10140-1,2,4,5/ EN ISO 717-1	Airborne sound insulation	Rw (C;Ctr)= 63(-1;-7)